

HyBrid Convertible Groomer HY72

**A Multi Purpose,
Convertible,
Easy to Use
Machine for Infields,
Turf and More!**

Hybrid HY72 Groomer Convertible Groomer

**Converts (without tools) for
Grooming Infields, Turf, and More!**

HyBrid
Infields
Turf
HY72

HyBrid Groomer

5 Electric Lift Systems
to Choose From
Most "Lift Control Systems" on the Market!

**The Only "Convertible Groomer" on the Market. Infields & Turf!
Converts in 60 Seconds.**

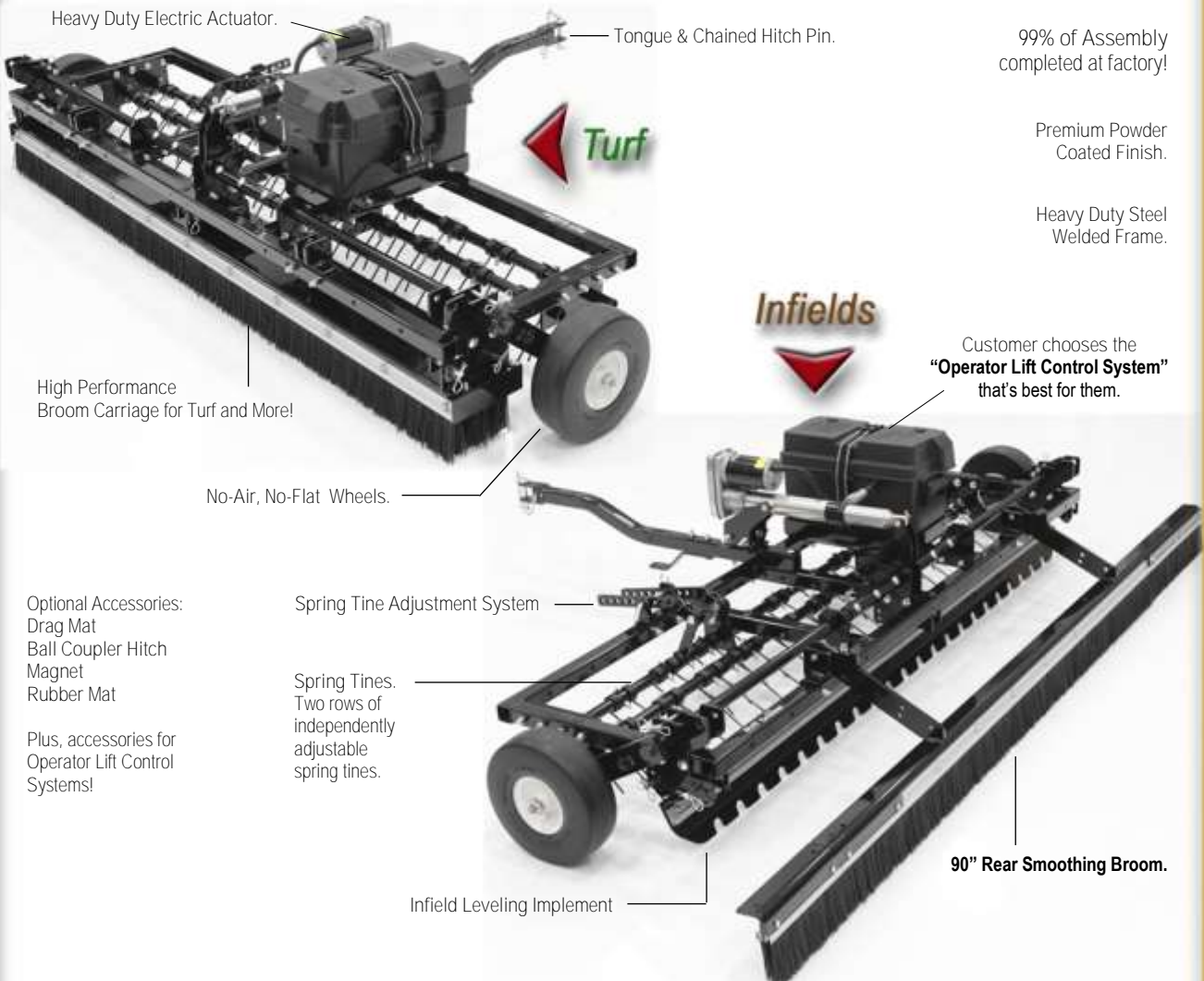

TURF MAINTENANCE

INFIELD GROOMING

OFF FIELD MAINTENANCE

The "First and Only Convertible Hybrid Groomer" that does it all! True Versatility.



- Groom and Maintain all types of Synthetic & Natural Turf
 - Natural Turf Sports Fields, such as Baseball-Softball Grass Outfields Soccer Fields Football Fields and Golf Greens Pulverize Aeration Cores, Incorporate Top Dressing, De-Thatch and More!
 - On Artificial Turf Bring turf back to life by lifting matted down fibers to promote water drainage, improve looks, and level infill.
 - Heavy Duty Steel Construction
 - Powder Coated finish
 - Pull with a variety of tow machines
 - No tools needed to adjust
 - Easy to Use
 - Affordable
 - Saves Labor
- Levels - Mixes - Smoothens (**90" Wide Rear Finishing Broom**)
 - Leveling Implement "**Locks in position to guarantee leveling takes place**"
 - Cuts High Areas and Fills Low Areas
 - Makes Renovating Easy
 - Reduces Need for Hand Raking
 - Tines used to shatter & pulverize
 - Maintains safer playing surface
 - Deters water puddling
 - Control Weeds
 - Heavy Duty Steel Construction
 - Powder Coated finish
 - Pull with a variety of tow machines
 - No tools needed to adjust
 - Works on all infield materials
 - Easy to Use
 - Affordable
 - Saves Labor
- Vibra Tine Spring Tines loosen rock and gravel while High Performance Broom Carriage fills pot holes, washout, etc.
 - Makes Renovating Easy
 - Effective on Driveways, Yards, Parking Lots, Trails, and More!
 - Heavy Duty Steel Construction
 - Powder Coated finish
 - Pull with a variety of towing machines
 - No tools needed to adjust engineering
 - Easy to Use
 - Affordable
 - Saves Labor



"We Make Dirt & Turf Look Good"

Helping Those Who Help Others Play!

Warranty (in a nutshell): Heying Company machines carry the following warranty on parts and workmanship, to be free of defects, under normal and intended use and service conditions, of:

Three (3) years parts and workmanship on Heying Company manufactured parts.

One (1) Year on parts not manufactured by Heying Company, including but not limited to:

Wheels, brushes, electrical cylinder (actuator), electric system parts, wireless remote control systems, switches, batteries, chargers, etc.

Excluded is this warranty is Normal Wear and Tear on Parts resulting from natural and intended use.

(Note: Warranty above is a partial writing - for a complete warranty please inquire. If you discover a better warranty on similar equipment we would like to see it).

HY72 HyBrid Groomer. Manufactured with "versatility" in mind.

Convertible. Adjustable. Easy to Use. Easy to maintain.

Shown Below is "Standard Equipment" When You Order the HY72 Groomer.

Standard
Equipment HyBrid

Converts from one
use to another.

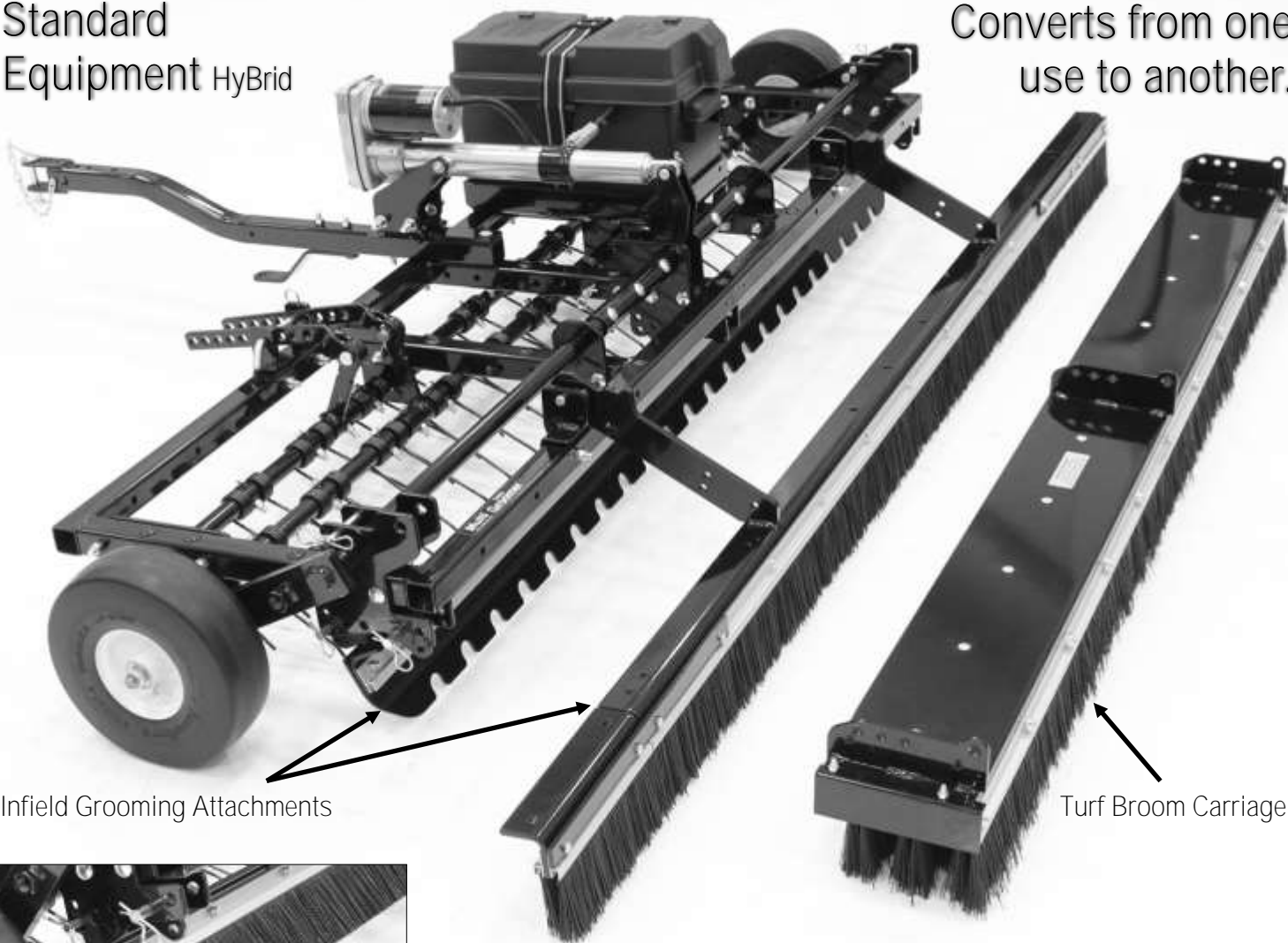

Infield Grooming Attachments

Turf Broom Carriage.



(Included) Brush behind the Leveling Implement (Not shown in some photos).



Tine Adjustment System. Easy to choose and set to make the amount of contact desired.



Tongue Hitch Adaptor (included).
Adjust Tongue Height.



Extra Pin Storage at each end of machine by axle.

Changing Implements - Quick and Easy!
 No tools needed. Simply pull clevis pins to switch implements.



Turf Setup. Broom Carriage with optional Rear Magnet.

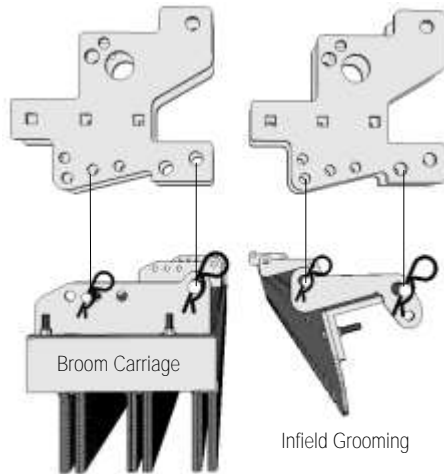

Infield Setup. Leveling Implement with Rear Smoothing Broom.

Have Turf & Infield Maintenance Needs?
 Our Hybrid Groomer is the only machine on the market that includes implements for Turf and Infield Grooming.



Optional Rear Magnet.
 Removes debris.
 Strongest magnets on the market!



Infield Setup - shown with optional rear drag mat.

Did You Know...Infill Can Fly!
 Of course you did. You've seen it on TV.
 You'll also see "infill in motion" when grooming synthetic turf with the Hybrid Groomer.



Infield Grooming made easy.
 Spring Tines pulverize when needed. Leveling implement and rear finishing broom groom infields.



Optional Accessories

MGMT-7200 Magnet



What's Hiding in Your Turf?





Ferrous metal objects such as track spikes, bobby pins, safety pins, nails, and other objects create hidden dangers to athletes and degrade synthetic turf. Removes this debris while grooming.

Strongest Magnet on the Market!







Optional Rear Magnet. 72" wide. Aluminum and stainless steel housing for Neodymium Rare Earth Magnets. Strongest available. Also includes adjustable height anti scalp turf wheels. Removes ferrous debris from Turf while grooming.

When you're comparing turf groomers be sure to ask what type of magnets are used. For example:



Other machines use less expensive ceramic magnets. Our neodymium magnets are 10 times stronger than ceramic !

ALDM-8436 For Infields	MGDM-8436 For Turf	MGRM-7200
<p>For Infield Use. Use behind Infield Leveling Implement and Rear Broom. Drag Mat with Brackets (Attaches to Rear Broom)</p> <p>ALDM-8436 Includes a Drag Mat and Brackets. 84" wide x 36" deep steel mat and our exclusive brackets that hold, carry and pull the mat so no need to hand carry the drag mat on and off the field. Easy to connect and remove.</p> <p>Exclusive Brackets pull, carry and haul the drag mat.</p> <p>ALDM-1000 Brackets Only. You can purchase our exclusive drag mat brackets and use your own drag mat. Brackets bolt to the Rear Finishing Broom frame. They hold, carry and pull the drag mat. Locks flip up and down making it easy to attach and remove mat.</p>  	<p>For Turf Use. Use behind 6 Brush Broom Carriage on Turf. The tall Broom Carriage requires a special rack to hold, pull, and carry a drag mat for turf. Rack attaches directly to rear of frame. 84" wide x 36" Deep Drag Mat. Rack included. Easily connects to rear of frame with quick pins.</p> <p>MGRK-4200 Rack Only You can purchase our exclusive drag mat rack and use your own drag mat. Rack connects to rear of frame with quick pins to hold and carry a drag mat. Easy to attach and remove from frame.</p> <p>Drag mat rack is welded construction. Holds, carries and pulls drag mat.</p> 	<p>Rubber Mat 72" Rubber Mat is useful on turf when pulverizing aeration cores, incorporating top dressing and when grooming artificial turf.</p> <p>Multi-purpose. Heavy duty. Welded frame.</p> 

Machine Options-Accessories

<p>AL-E-552 "HW"</p>	<p>AL-E-098 Transmitter</p>	<p>Backup Electric Control Systems. Want Dual Controls.</p>		
<p>Additional "HW" partial wiring pkg. If you order the "HW" Lift System you might want to wire an additional tow vehicle to pull the groomer. Includes necessary wiring to "Hard-Wire" one additional tow machine.</p> 	<p>Additional Wireless Transmitter for "WR" or "PW" Systems.</p> <p>For customers who have "WR" or "PW" Lift System. When you order consider an additional transmitter so you have an extra on hand.</p>  <p>AL-E-098</p> <p>We stock Transmitters</p>	<p>Who needs a Backup Electric Control System? Can't be broke down? Need peace of mind that you have a backup control system to operate the groomer if something happens to your original lift system, like a dead battery, misplaced transmitter, broken wire, etc.? Then consider a "backup" control that will bypass the entire original electric lift system except the cylinder. Choose a backup system that has temporary alligator clamps or ring terminals to connect to tow vehicle or groomer 12v battery.</p>		
		<p>AL-E-555 "SB" Backup</p>	<p>AL-E-571 "PW" Backup</p>	<p>AL-E-589 "SG" Backup</p>
		<p>Most Popular Backup Control. "SB" Corded Switch Box Control System. "SB" uses temporary alligator clamps to attach to your tow machine 12 volt battery and totally bypass the original system. See SB Wiring System for more details.</p> 	<p>"PW" Portable Wireless Control System. "PW" uses temporary alligator clamps to attach to your tow machine 12 volt battery and totally bypass the original system. See PW Wiring System for more details.</p>  <p>AL-E-098</p>	<p>"SG" Corded Switch Box Control System. "SG" connects to the 12 volt battery on the groomer with 3/8" Ring Terminals and can bypass the original system. See SG Wiring System for more details.</p> 
<p>MGCP-1875 (1-7/8")</p>		<p>Ball Coupler Hitch 1-7/8" or 2" Coupler sizes available. Easily mounts to end of tongue.</p>		
<p>MGCP-2000 (2")</p>				

5 Electric Lift Systems & How They Work

<p>12v Battery Included</p> <p>Wireless</p>  <p>WR₂₃</p> <p>Complete 12 Volt Electric System On-Board Grommer</p> <p>Does not use Tow Machine Battery.</p> <p>Includes 12 Volt Battery, 2.0 amp Battery Charger and Battery Monitor</p> <p>Includes all-in-one Emergency Rocker Switch & Cord 11.5 ft. long</p> <p>12 Volt Battery On Grommer</p>	<p>Battery On Grommer WR. Battery on Grommer.</p> <p>Wireless Remote Control. 12V Battery and Elec System On-Board the Grommer.</p> <p>No wires to attach to your Tow Machine. 12 Volt battery, wireless transmitter & receiver system, 2.0 amp battery charger, and battery monitor. Great choice for ease of use, convenience, and all day use. Includes emergency 11.5 ft. long all-in-one Rocker Switch & Cord (use as emergency / temporary backup control).</p> <p><i>Note: SG system also has a 12v battery on board the groomer.</i></p>
<p>Corded SwitchBox</p> <p>Powered by 12v Battery On Grommer</p>  <p>SG₂₂</p> <p>Does not use Tow Machine Battery.</p> <p>4 Way Wire System provides power from battery on groomer to switchbox and back to electric cylinder.</p> <p>Includes 2.0 amp Battery Charger & Battery Monitor</p> <p>12 Volt Battery On Grommer</p>	<p>Battery On Grommer SG. Battery on Grommer.</p> <p>Corded SwitchBox Control. 12V Battery On-Board Grommer. Does not use 12v battery of your Tow Machine. Corded system. Weather sealed SwitchBox. 2 Extension Wires to work for all tow machines. Groomer tongue wire connects to extension wire at rear of tow machine. Good choice for all day use. <i>Note: WR is the only other system that has a 12 volt battery on-board the groomer. Can also be used as a backup operating system.</i></p>
<p>Corded SwitchBox</p> <p>Powered by Tow Machine Battery</p>  <p>SB₁₉</p> <p>Does not use Tow Machine Battery.</p> <p>Store Electric System Parts in Battery Compartment.</p> <p>User Tow Machine Battery</p>	<p>Uses Battery of Tow Machine SB. Corded SwitchBox.</p> <p>Uses Tow Machine 12v Battery. Corded system with Weather sealed SwitchBox. Power Harness connects to tow machine battery with portable alligator clamps. Includes 2 Extension Wires to work for all tow machines. Groomer tongue wire connects to extension wire at rear of tow machine.</p> <p><i>Can also be used as a backup operating system.</i></p>
<p>Portable Wireless</p>  <p>PW₂₃</p> <p>Does not use Tow Machine Battery.</p> <p>Includes all-in-one Emergency Rocker Switch & Cord 11.5 ft. long</p> <p>User Tow Machine Battery</p>	<p>Uses Battery of Tow Machine PW. "Portable" Wireless Remote Control.</p> <p>Uses Tow Machine 12v Battery. Same wireless control system as the "WR".</p> <p>Power Harness connects to tow machine battery with portable alligator clamps. Power supplied to wireless receiver on groomer through groomer tongue wire connected at rear of tow machine. Includes emergency 11.5 ft. long all-in-one Rocker Switch & Cord (use as emergency / temporary backup control).</p> <p><i>Can also be used as a backup operating system.</i></p>
<p>Hard-Wired</p>  <p>HW₂₁</p> <p>Does not use Tow Machine Battery.</p> <p>Store Tools, etc. in Battery compartment.</p> <p>User Tow Machine Battery</p>	<p>Uses Battery of Tow Machine HW. Hard-Wired into your tow machine.</p> <p>Uses Tow Machine 12v Battery. Dash-Mounted Rocker Switch to control the electric lift. You dedicate a specific tow machine to be wired. Includes all wiring, switch, connectors, etc. for one tow machine. Want to use other tow machines when needed? Order optional partial wiring system to wire another tow machine or order an optional backup system.</p> <p><i>Note: your tow machine must have a knock-out switch location available on the dash for rocker switch or cut your own opening.</i></p>



“WR” Wireless Remote Control + On-Board 12v Electric System

WR

Wireless remote operator control with On-board 12v battery provides the ultimate in user ease and flexibility. Exclusive wireless remote transmitter and receiver, on-board 2.0 amp battery charger, battery monitor (alerts when battery needs charged), plastic battery case, sealed connectors, emergency bypass rocker switch & cord, and 2 manual tools.

Most Popular

Nothing Else like it on the market!

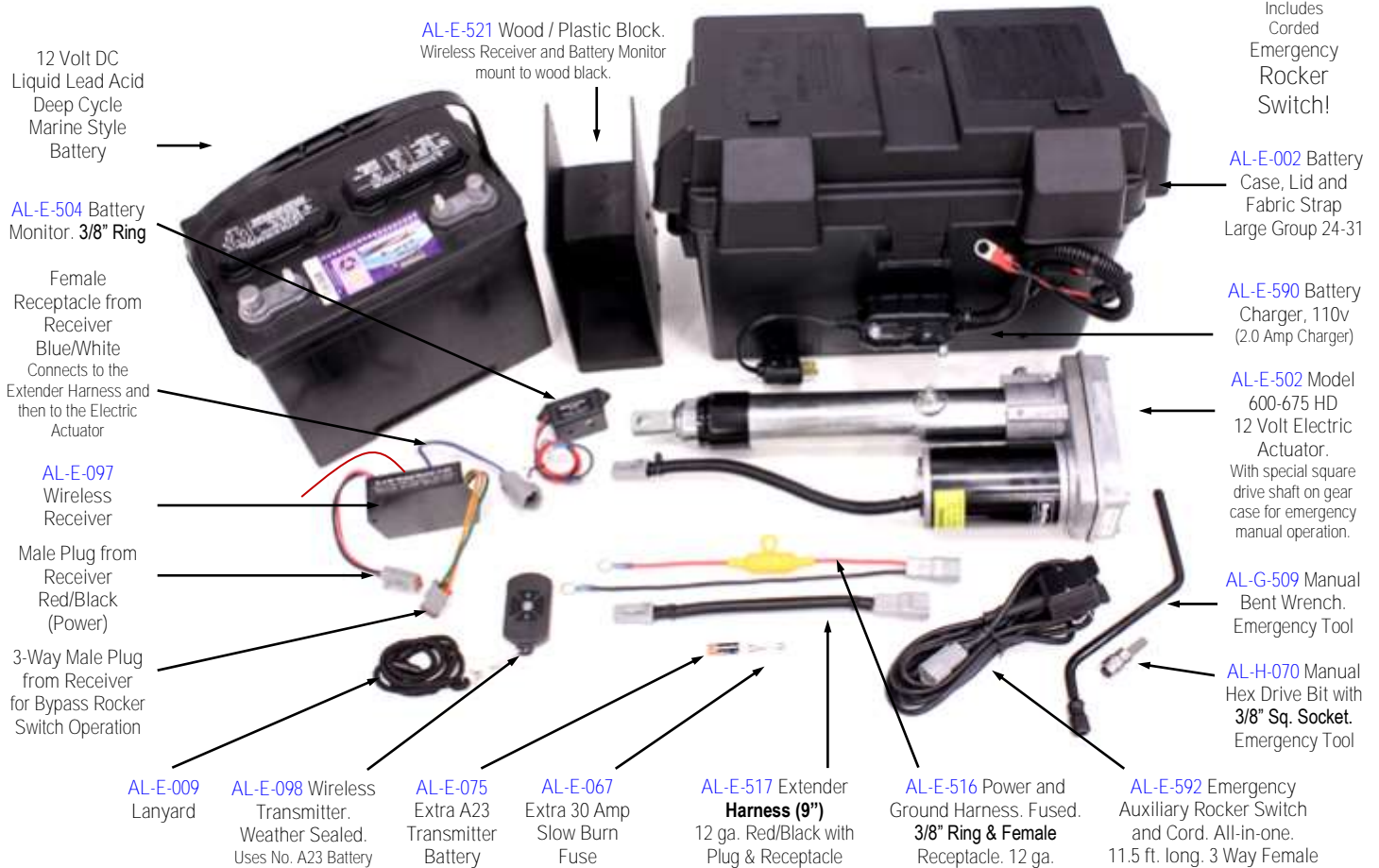

Advantages: **Exclusive “one-of-a-kind” control system....only offered by Heying Company! Made in USA!**

Wireless Remote (hand held transmitter) Control - the Ultimate in user convenience (receiver mounts inside battery compartment).

The wireless remote control has immediate response when a button is pressed. It never goes to sleep like many other wireless systems.

Pull with a variety of tow machines. Can quickly switch from one tow machine to another. On-board electric system is completely self contained.

On-board 2.0 amp battery charger has safe technology so it can (and should) be plugged in whenever the groomer is not being used.

On-board battery monitor emits an audible alert when the battery needs to be charged.

No wiring needed to user tow machine. No Cords.

Corded Auxiliary Switch (and cord) included. 11 ft. long. Use to operate electric lift if transmitter is misplaced. Stores inside battery case.

On-board electric system also makes it easier to move the groomer even when it's not connected to a tow machine (such as inside a storage shed).

Disadvantage: (Not really a disadvantage) User needs to keep the on-board battery charged. Just plug in the battery charger (use a standard 120v cord).



Great Backup Control

Worried about losing the Transmitter? System comes with 11.5 ft. long Corded Rocker Switch and two (2) manual wrenches that can be used in an emergency to manually raise / lower the electric cylinder. **Consider a “Backup Control System”.** Customers who run tournaments or those who just want the peace of mind that they can operate the groomer if they have any problems (misplaced transmitter, dead battery, etc.)...will consider the “SB” Backup Operating System. The “SB” System is portable and can connect to any tow machine 12v battery. It's not used on a daily basis. Rather, it's stored, and used only when there is a problem with the main control system. It will override / bypass the entire original electric system (except the Cylinder).



Corded SwitchBox Control powered by 12V Battery On-Board the Groomer.

SG

12 volt battery on-board the groomer means your tow machine battery is not used to power the system. This is a good choice for those who need to use the groomer all day long - **so they don't wear down their tow machine battery.** Note: WR is the only other system that has a 12 volt battery on-board the groomer.



How it Works. Power starts at the groomer battery. The 4 Conductor Tongue & Power Wire runs 2 way power towards the operator (through whichever extension wire is used) and onto the SwitchBox. From switch 2 way control is returned to the actuator on groomer.

The 12 ft. length extension wire is popular with customers who have UTV type tow machines. The 5 ft. length extension wire is popular with customers who have shorter tow machines such as garden tractors.

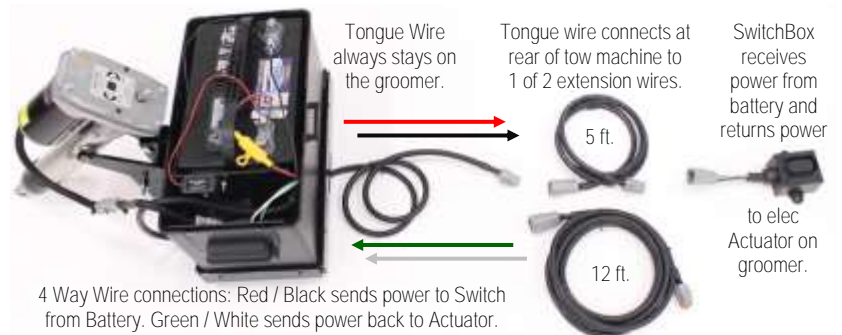

Advantages: 12 volt electric system completely on-board the groomer provides all the power needed for lift / lower functions.

Your tow machine battery is not needed to power the groomer electric lift (doesn't wear down your tow machine battery). Provides all day use.

On-board 2.0 amp battery charger has safe technology so it can (and should) be plugged in whenever the groomer is not being used.

On-board battery monitor emits audible alert when the battery needs to be charged.

Versatile, Easy to Use, and Portable. Pull groomer with a variety of tow machines. Made in USA!

Disadvantages: Inconvenience of having cords. Must pay constant attention to protecting the cords during use.

Note: This SG System is one of two systems we offer with 12 volt battery on-board the groomer (WR is the other).



Corded SwitchBox Control powered by your Tow Machine 12v Battery.
Hand held corded SwitchBox controller connects to the user's tow machine 12v battery (with alligator clips) to supply power to the electric lift on the groomer. Portable. Easy to move from one tow machine to another.
 Includes two extension wires. **12 ft. long extension wire popular with customers who have long UTV's and the 5 ft. long extension wire popular with customers who have shorter tow machines such as garden tractors.**
Can be used as a everyday lift control system, or, as an optional backup to other operator lift control systems.

SB

SB

AL-E-105
 Convoluted Split Loom. 8 ft. x .350
 Use to protect Power and Ground Wire Harness.

AL-E-578 12 ft. Extension Wire (often used for larger tow machines).

AL-E-577 5 ft. Extension Wire (often used for shorter tow machines such as garden tractors, 4-wheelers, etc.)

AL-E-101
 SwitchBox 2 x 2
 Power & Control

AL-G-094
 Zip Ties

AL-G-012
 Zip Tie Inserts

AL-E-575 Fused Power & Ground Wire Harness with Alligator Clamps & Female Receptacle. 8 ft. long.

AL-E-576
 Groomer Tongue Wire (70") with Split Loom

AL-E-067
 Extra 30 Amp Slow Burn Fuse

AL-E-035
 Ring Terminals 3/8"

AL-E-038
 Butt Splice 14-16

AL-E-002 Battery Case, Lid and Fabric Strap Large Group 24-31

AL-E-502
 Model 600-675 Actuator (with 12-14 Male Plug)

AL-G-509 Manual Bent Wrench. Emergency Tool

AL-H-070 Manual Hex Drive Bit with 3/8" Sq. Socket. Emergency Tool

AL-G-107 Cable Clamps .406 x .50
 AL-G-015 Cable Clamp .406 x 1.00

Advantages:

Versatility to quickly switch to a different tow machine (control system is portable).

SwitchBox is completely weather sealed (unlike anything on the market). Made in USA!

Two "Cylinder Extension Wires" included (5 ft. and 121 ft.) so the user can decide which works best for their use.

Ability to be used as a primary (everyday) lift control system or as a backup to other operator lift control systems (use when needed).

No battery on-board the groomer to worry about (but it does need power from your 12v tow machine).

We include a battery compartment (even though a battery is not included). Very useful to store control parts and tools.

Disadvantages:

Inconvenience of having cords. Must pay constant attention to protecting the cords during use.

Big Users (who have lots of grooming) could experience this system wearing down the battery of their tow machine.

This system requires power from user tow machine. User cannot raise and lower implements without being attached to tow machine for power.

Since power is supplied by a tow machine the groomer is more difficult to move around storage shed, etc.

Note: We have 2 Systems (WR and SG) that provide 12 volt power from the groomer so they don't need power from your tow machine.



“PW” Portable Wireless Remote Control.

PW

Same wireless Transmitter - Receiver as the “WR” but uses 12v battery of user’s Tow Machine for power. Includes portable power harness that connects to tow machine battery. The groomer also has a connection harness.

These two wires connect at the rear of the tow machine to power the electric system.

“Worried about losing the Transmitter”? We include a corded auxiliary rocker switch & cord that can be used as a temporary backup control of the electric lift if you misplace the wireless transmitter.

Unlike anything else on the market!

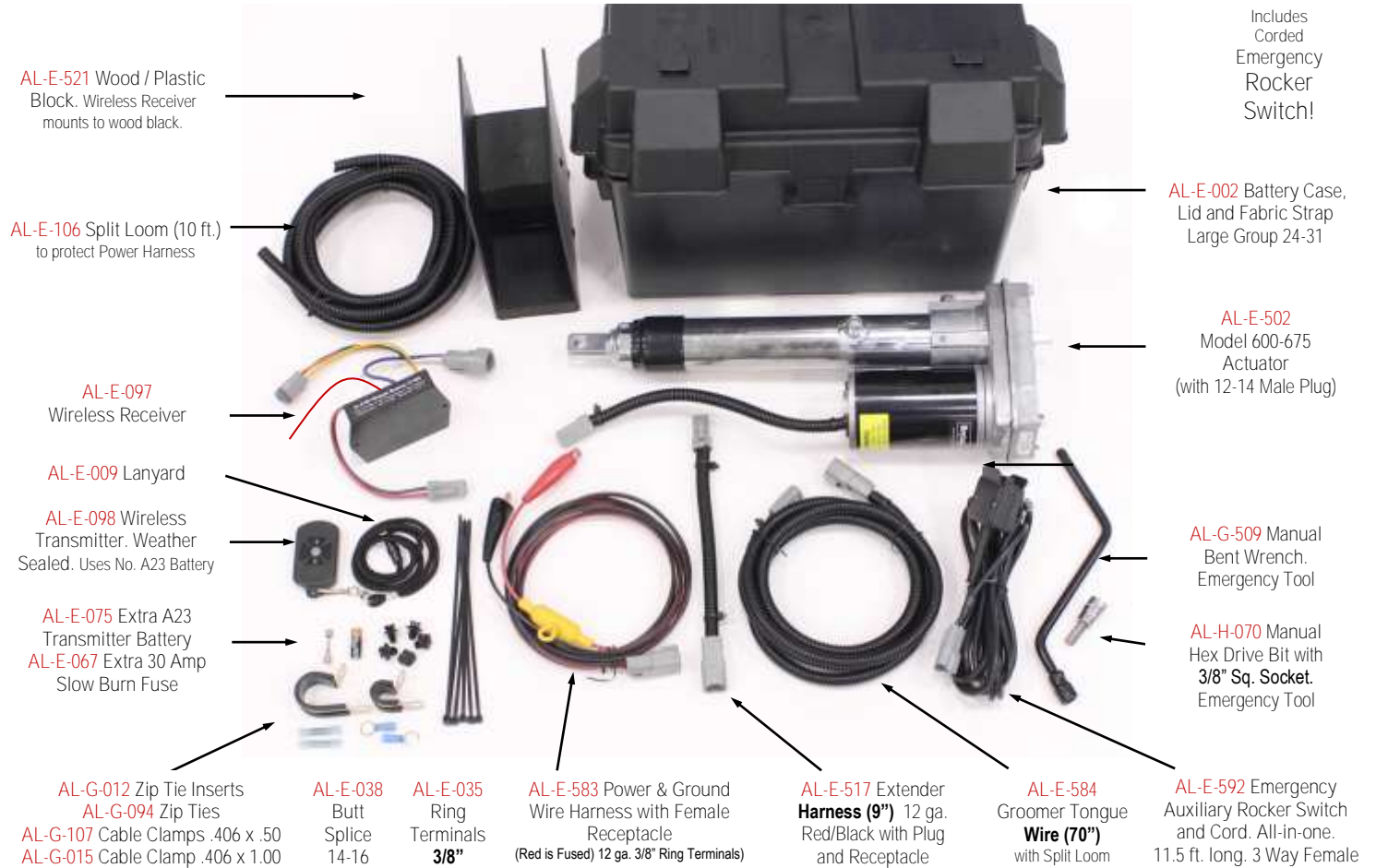

Advantages:

Wireless Remote Control System for “the Ultimate in User Convenience” at a lower price than the “WR”.

The wireless remote control has immediate response when a button is pressed. It never goes to sleep like many other wireless systems.

Lighter weight than the “WR” system (No battery so is not as heavy to lift the tongue). Advantage especially for those who want the Spring Tine Scarifier on their groomer (Spring Tine Scarifier mounts to front of machine thus adding weight to the Tongue).

Portable System. Pull with a variety of 12 volt tow machines. Can quickly switch from one tow machine to another.

Disadvantages:

Inconvenience having to plug in the connector (when connecting to tow machine) and unplugging connector behind tow machine (when unhooking).

For some big users (lot of fields or lots of grooming on fewer fields) this system could wear down the battery of the tow machine.

If this is a concern then consider the “WR” system.

This system requires power from user tow machine 12v battery. User can’t raise or lower implements without being attached to tow machine for power.

Note: The “WR” is the only system that does not require power from user tow machine.



Great Backup Control

Worried about losing the Transmitter? System comes with 11.5 ft. long Corded Rocker Switch and two (2) manual wrenches that can be used in an emergency to manually raise / lower the electric cylinder. **Consider a “Backup Control System”.** Customers who run tournaments or those who just want the peace of mind that they can operate the groomer if they have any problems (misplaced transmitter, dead battery, etc.)...will consider the “SB” Backup Operating System. The “SB” System is portable and can connect to any tow machine 12v battery. It’s not used on a daily basis. Rather, it’s stored, and used only when there is a problem with the main control system. It will override / bypass the entire original electric system (except the Cylinder).



“HW” Hard-Wired Operator Lift Control System (12v only)

HW

System uses 12v battery of your tow machine. Includes all necessary wiring, in-dash mountable rocker switch, electric cylinder (actuator), fuse holder, fuse, wire, connectors, protective split loom, cable clamps, and zip ties.

For users who have a tow machine with a dash panel that will accept a Rocker Switch, who want the convenience of a dash mounted rocker switch, and who want to always use the same tow machine to pull and operate the groomer this is the operator system of choice. Note: Optional additional wiring package available for users who wish to wire more than one tow machine to pull and operate the groomer. See optional “HW” tow machine wiring package information.

AL-E-102
8 ft. of .350
Convoluted
Split Loom.
Use to protect
Power Harness.

AL-E-103
16 ft. of .350
Convoluted
Split Loom.
Use to protect wire
when installed
inside tow ma-
chine.

AL-E-512
Tongue Wire
70". Female
Receptacle one
end and Red
SMS Connector
at other end.

AL-E-014
Rubber Cover



AL-E-513 16 ft. Switch to Rear of
Tow Machine Wire. Blue push-on
connectors & Red SMS Connector.
AL-E-014 Rubber Cover.

AL-E-514 8 ft. Power Harness.
Switch to Battery of Tow
Machine. 3/8" Ring Terminals
and Red SMS Connector.

AL-E-067
Extra
Fuse

AL-E-089
Push-On
Connectors
Crimp Only

AL-E-029
Push-On
Connectors
Heat Shrink

AL-G-012
Zip Tie
Push in
Inserts

AL-G-107
Cable
Clamp
.406 x .50

AL-G-015
Cable
Clamp
.406 x 1.00

AL-E-002 Battery
Case, Lid and
Fabric Strap
Large Group 24-31

AL-E-502 Model
600-675 HD
12 Volt Electric
Actuator.
With special square
drive shaft on gear case
for emergency manual
operation.

AL-E-011 Dash
Mount
Rocker
Switch Momentary
4 Contact. Fits hole
size range of: .820"
to .830" wide X .142"
to .148" high.

AL-G-509 Manual
Bent Wrench.
Emergency Tool

AL-H-070 Manual
Hex Drive Bit with
3/8" Sq. Socket.
Emergency Tool

Advantages: Rocker Switch is installed on dash of Tow Machine for convenience.

Easy to use connectors at the groomer tongue and rear of tow machine.

Disadvantages: User must dedicate a specific tow machine to always pull the groomer. Or, order additional wiring packages for more tow machines. You can also consider an optional SB or SG or PW System to use as a portable backup for when the original dedicated tow machine is not available to pull the groomer.

See optional accessories).

Big Users (who have lots of grooming) could experience this system wearing down the battery of their tow machine.

Since power is supplied by a tow machine the groomer is more difficult to move around storage shed, etc.

Note: The “WR” and “SG” systems have 12v batteries on-board the groomer. They do not need to connect to the user’s Tow Machine to power the groomer.

How it Works

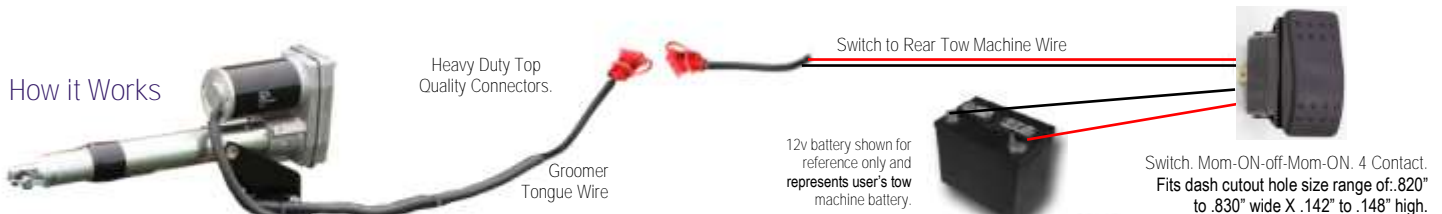

Great Backup Control

“HW”. Concerned about having only one Tow Machine able to operate the groomer? Consider an additional “HW” Wiring package (optional) to wire a second Tow Machine. Or consider a “Backup Control System”. Customers who run tournaments or those who just want the peace of mind that they can operate the groomer if they have any problems (misplaced transmitter, dead battery, etc.)....will consider the “SB” Backup Operating System. The “SB” System is portable and can connect to any tow machine 12v battery. It’s not used on a daily basis. Rather, it’s stored, and used only when there is a problem with the main control system. It will override / bypass the entire original electric system (except the Cylinder).

WARRANTY (All Groomers from Heying Company)

Heying Company machines carry the following limited warranty, from date of possession to the end user, on parts and workmanship, and to be free of defects, under normal and intended use and service conditions, of:

3 years parts and workmanship on Heying Company manufactured parts.

One (1) Year on parts not manufactured by Heying Company, including but not limited to:

Wheels, brushes, electrical cylinder (actuator), electric system parts, wireless remote control systems, switches, batteries, chargers, etc.

Excluded is this warranty is Normal Wear and Tear on Parts resulting from natural and intended use.

Heying Company's obligation under this warranty is limited to replacement or repair at the manufacturer's option.

Proof of purchase must accompany any and all warranty claims to Heying Company.

This warranty does not extend to any product or damage to a product caused by, or attributed to freight damage, abuse, misuse, improper or abnormal usage, improper storage or changes and repairs unauthorized by Heying Company including to towing machines.

All freight damage claims must be made immediately and directly to the freight carrier by the purchaser or end user. It is not the responsibility of Heying Company to report damaged freight to freight companies. We guarantee that all shipments leave our facilities free from damage.

Heying Company is not liable for direct or indirect, special or consequential damages arising from, or in connection with, the use or performance of the product or damages with respect to any economic loss, personal injury, loss or damage to property, loss of revenues or profits, or loss of enjoyment.

Any full machine, assembly or individual part returned to Heying Company for refund, replacement or repair must have sufficient proof of purchase included, prior written authorization from Heying Company, be packaged as instructed by Heying Company, and have all freight charges prepaid.

Product returns are subject to re-painting and re-stocking charges.

No other warranty beyond that specifically stated above is authorized or intended by Heying Company.

Choosing a tow machine is the sole responsibility of the user. User should always consult with the towing machine manufacturer for towing capacity and suitability. Heying Company makes no claim and carries no responsibility as to the ability or capacity of any towing machine to be used.

Participants acknowledge that operating motorized vehicles, with towed or attached equipment, can be an extreme test of a person's physical and mental limits and carries with it the potential for death, serious injury and property loss. The risks include, but are not limited to, those caused by terrain, vehicular traffic and the actions of other people including, facilities, temperature, weather, and physical and mental fitness. These risks are not only inherent to equipment operators but are also present for volunteers and anyone else desiring to participate in these activities. Participants acknowledge, agree and represent that they will inspect the equipment to be used or operated by him/her. Participant agrees and warrants that, if at any time, he/she is in or around the equipment that they will immediately advise appropriate officials of such, and if necessary, leave the area or equipment and/or refuse to further participate in these activities if they are unable to successfully do so.

Acknowledgment and Assumption of Risk. Release of Liability; Indemnification.

Rear attach groomers are designed to attach directly to a customer's vehicle, tractor, etc. (and will not include a wheeled frame or tongue for pulling). The desire for direct attach groomers comes from customers needing "convenience". Even though these types of groomers could prove to be somewhat less effective there are customers who understand this and are willing to sacrifice some function to gain convenience. Examples of vehicles used for "direct attach groomers". Utility vehicles like the JD Gator TX. UTV's, Side by Sides, Small Tractors, etc. Heying Company is not responsible for damage or harm to vehicles, or to person's operating the vehicle and / or groomer. Customer agrees that they are solely responsible to attach to and operate their vehicle or Tow Machine, they understand they are responsible to assure the safety of operators, and that they willingly attach this groomer to their tow machine with full knowledge that they are responsible to make sure it will not cause damage to their vehicle or any person operating the vehicle. Customer acknowledges that by ordering a groomer they have read and understand all aspects of their responsibility of pulling, attaching, and operating all equipment.

Release of Liability; Indemnification; Acknowledgement of Risk. Participant hereby waives, releases and discharges, on behalf of Participant and Participant's executors, administrators, heirs, next of kin, successors and assigns, Heying Enterprises and authorized dealers, and their respective directors, officers, employees, volunteers, agents from any and all liability for customer's death, disability, personal injury, property damage, property theft, lost income or any other losses, costs or actions of any kind whatsoever, which hereafter may directly or indirectly accrue to customer through training or participating in the act of use of Heying Equipment and their Tow Vehicles. Customer agrees to indemnify and hold the Releasees harmless from and against any and all liability, loss, damage or injury as well as all costs and expenses (including attorneys' fees and costs of any suit related thereto), suffered or incurred by Releasees, to the extent arising from any of customer actions whatsoever whether now or in the future, including but not limited to negligent, intentional or reckless misconduct, acts or omissions. Participant understands that there are inherent hazardous risks associated with the operation of equipment which could include serious injury or death, and customer freely assumes the risk of any and all injuries that customer may sustain while using this equipment. Customer agrees that no person with insufficient physical fitness, alertness, sobriety, vision, or medical ability shall operate the equipment and that all operators shall have adequate training before being allowed to operate said equipment.

Governing Law. Except to the extent that this Agreement may be governed by any federal law, this Agreement shall be governed by, construed and interpreted under, and enforced exclusively in accordance with the laws of the State of Iowa in the United States.